

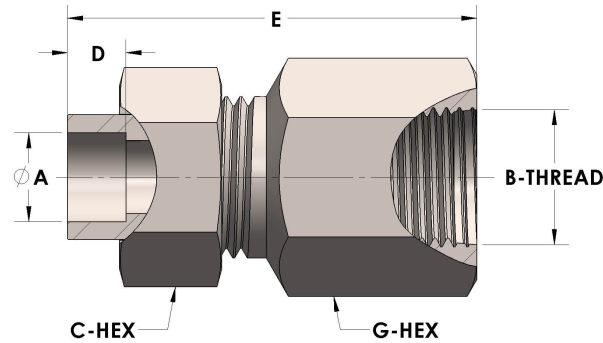

**Product Category**  
**Part Description**

H864-08-12-SS316L  
Tube to Female Straight Thread Union Assembly



## DIMENSIONS

A	0.500
B-THREAD	1.063" - 12UN
C-HEX	1.38
D	0.310
E	2.44
G-HEX	1.38

## GENERAL

Pressure Rating	4500 PSI
Assembly Material	316/L Stainless Steel, ASTM A276, UNS S31600/03
O-Ring Material	Viton® Fluorocarbon Type 1, Class 2 (90 durometer)
Connection 1 Type	Female Tube Socket
Connection 1 Size	1/2" Tube O.D. (-08)
Connection 2 Type	Female Straight Thread
Connection 2 Size	1.063" - 12UN (-12)