

Product Category

H865-04-08-M

Part Description

Direct Weld/Braze Insert (Male Pipe X Tube SW)

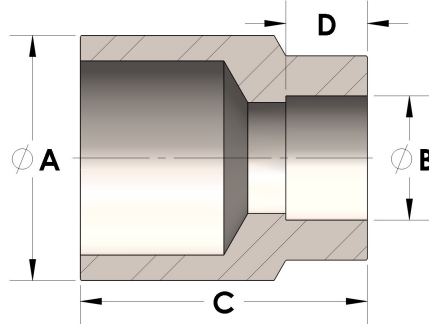

## DIMENSIONS

A	0.540
B	0.50
C	1.00
D	0.310

## GENERAL

Pressure Rating	6000 PSI
Fitting Material	Monel®, ASTM B164, UNS N04405