

Product Category

H865-08-06-S

Part Description

Direct Weld/Braze Insert (Male Pipe X Tube SW)

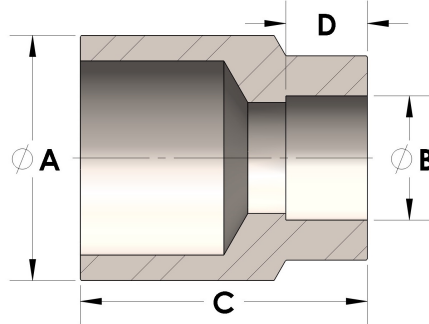

DIMENSIONS

A	0.840
B	0.38
C	1.00
D	0.250

GENERAL

Pressure Rating	6000 PSI
Fitting Material	Carbon Steel, ASTM A108