

Product Category

H865-12-06-S

Part Description

Direct Weld/Braze Insert (Male Pipe X Tube SW)

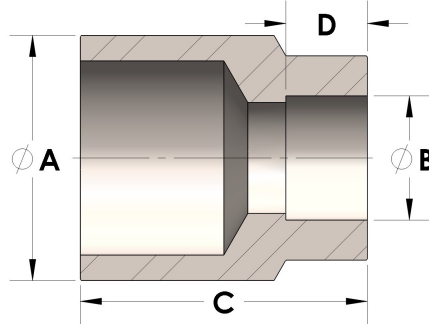

DIMENSIONS

A	1.050
B	0.38
C	1.25
D	0.250

GENERAL

Pressure Rating	6000 PSI
Fitting Material	Carbon Steel, ASTM A108