

Product Category

H865-12-12-S

Part Description

Direct Weld/Braze Insert (Male Pipe X Tube SW)

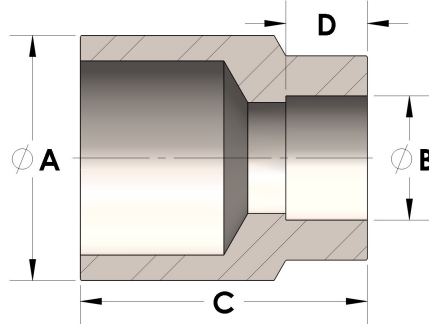

DIMENSIONS

A	1.050
B	0.75
C	1.25
D	0.440

GENERAL

Pressure Rating	4500 PSI
Fitting Material	Carbon Steel, ASTM A108