

Product Category

H865-16-08-SS316L

Part Description

Direct Weld/Braze Insert (Male Pipe X Tube SW)

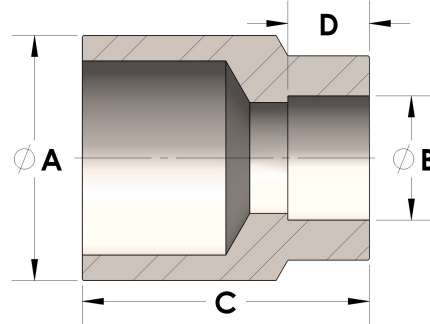

DIMENSIONS

A	1.315
B	0.50
C	1.38
D	0.310

GENERAL

Pressure Rating	6000 PSI
Fitting Material	316/L Stainless Steel, ASTM A276, UNS S31600/03