

Product Category

H865-16-20-S

Part Description

Direct Weld/Braze Insert (Male Pipe X Tube SW)

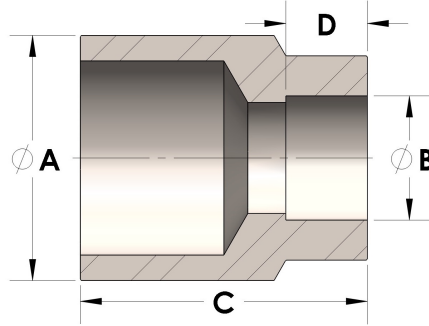

DIMENSIONS

A	1.315
B	1.25
C	1.63
D	0.560

GENERAL

Pressure Rating	6000 PSI
Fitting Material	Carbon Steel, ASTM A108