

Product Category

H865-20-16-M

Part Description

Direct Weld/Braze Insert (Male Pipe X Tube SW)

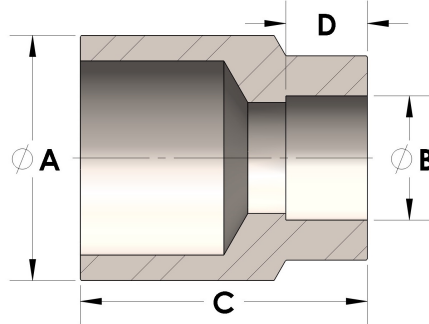

## DIMENSIONS

A	1.660
B	1.00
C	1.63
D	0.500

## GENERAL

Pressure Rating	6000 PSI
Fitting Material	Monel®, ASTM B164, UNS N04405