

Product Category

H865-32-20-S

Part Description

Direct Weld/Braze Insert (Male Pipe X Tube SW)

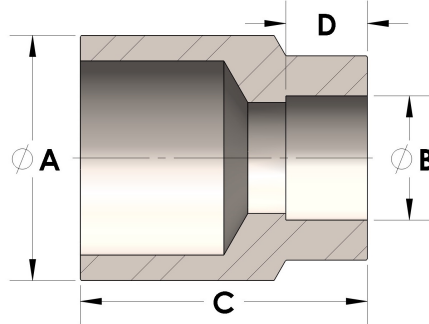

DIMENSIONS

A	2.375
B	1.25
C	2.00
D	0.560

GENERAL

Pressure Rating	3000 PSI
Fitting Material	Carbon Steel, ASTM A108