

Product Category

H866-04-08-S

Part Description

Direct Weld/Braze Insert (Male Tube X Pipe SW)

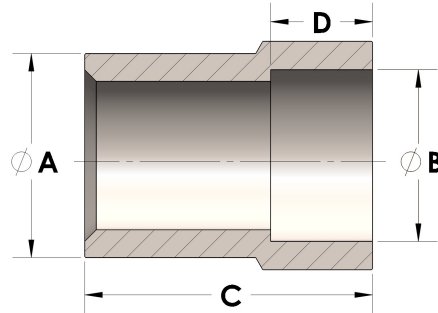

DIMENSIONS

A	0.250
B	0.85
C	1.38
D	0.380

GENERAL

Pressure Rating	6000 PSI
Fitting Material	Carbon Steel, ASTM A108