

Product Category

H866-06-02-M

Part Description

Direct Weld/Braze Insert (Male Tube X Pipe SW)

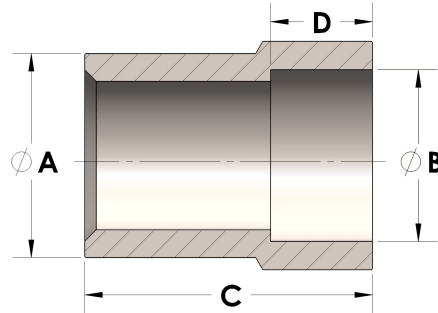

DIMENSIONS

A	0.380
B	0.41
C	1.13
D	0.380

GENERAL

Pressure Rating	6000 PSI
Fitting Material	Monel®, ASTM B164, UNS N04405