

Product Category

H866-08-08-M

Part Description

Direct Weld/Braze Insert (Male Tube X Pipe SW)

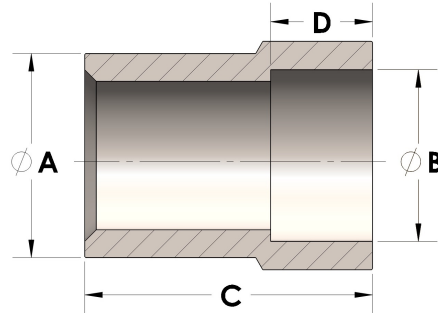

## DIMENSIONS

A	0.500
B	0.85
C	1.38
D	0.380

## GENERAL

Pressure Rating	4500 PSI
Fitting Material	Monel®, ASTM B164, UNS N04405