

Product Category

H866-12-08-SS316L

Part Description

Direct Weld/Braze Insert (Male Tube X Pipe SW)

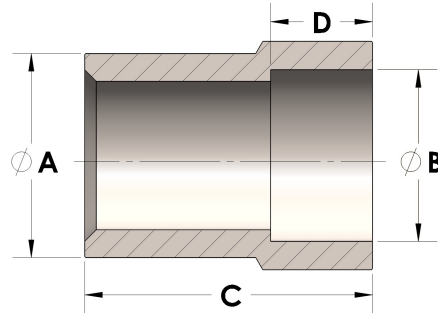

DIMENSIONS

A	0.750
B	0.85
C	1.38
D	0.380

GENERAL

Pressure Rating	3000 PSI
Fitting Material	316/L Stainless Steel, ASTM A276, UNS S31600/03