



Product Category

H866-16-16-M

Part Description

Direct Weld/Braze Insert (Male Tube X Pipe SW)

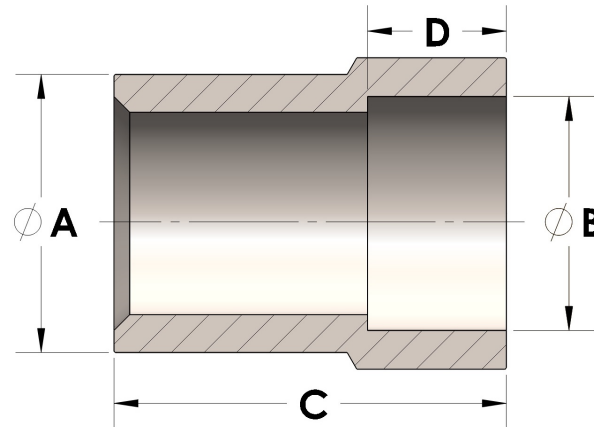

DIMENSIONS

A	1.000
B	1.32
C	1.75
D	0.500

GENERAL

Pressure Rating	4500 PSI
Fitting Material	Monel®, ASTM B164, UNS N04405

cpvmfg.com | 484.731.4010

The complete catalog contents must be reviewed to ensure that the system designer and user make a safe product selection. When selecting products, the total system design must be considered to ensure safe, trouble-free performance. Function, material compatibility, adequate ratings, proper installation, operation, and maintenance are the responsibilities of the system designer and user. Caution: Do not mix or interchange valve components with those of other manufacturers.