

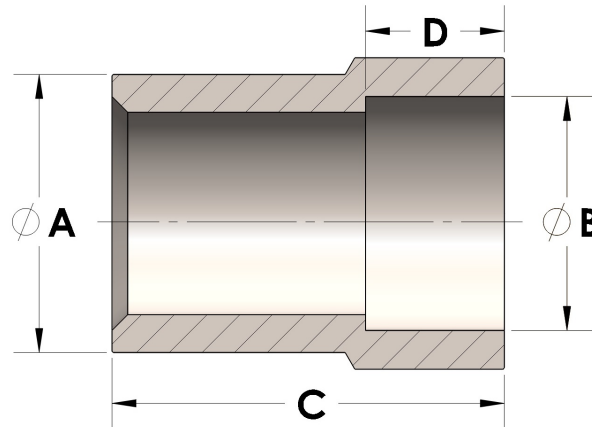

**Product Category**  
**Part Description**

H866-20-20-SS316L  
Direct Weld/Braze Insert (Male Tube X Pipe SW)



## DIMENSIONS

A	1.250
B	1.67
C	2.00
D	0.500

## GENERAL

Pressure Rating	3000 PSI
Fitting Material	316/L Stainless Steel, ASTM A276, UNS S31600/03

The complete catalog contents must be reviewed to ensure that the system designer and user make a safe product selection. When selecting products, the total system design must be considered to ensure safe, trouble-free performance. Function, material compatibility, adequate ratings, proper installation, operation, and maintenance are the responsibilities of the system designer and user. Caution: Do not mix or interchange valve components with those of other manufacturers.