

Product Category

H866-24-16-CUNI

Part Description

Direct Weld/Braze Insert (Male Tube X Pipe SW)

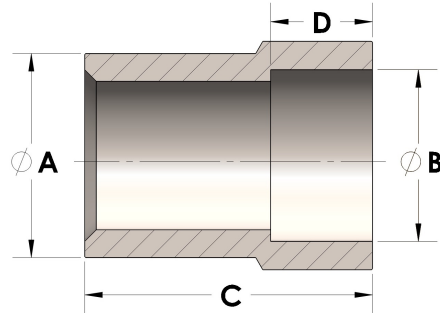

DIMENSIONS

A	1.500
B	1.32
C	2.13
D	0.500

GENERAL

Pressure Rating	2000 PSI
Fitting Material	Copper Nickel 70/30, MIL-C--15726F, UNS C71500