

Product Category

H867-06-02-S

Part Description

Direct Weld/Braze Insert (Male Tube X Tube SW)

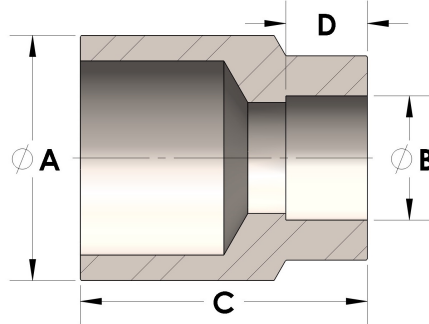

DIMENSIONS

A	0.380
B	0.13
C	0.69
D	0.190

GENERAL

Pressure Rating	6000 PSI
Fitting Material	Carbon Steel, ASTM A108