

Product Category

H867-06-04-M

Part Description

Direct Weld/Braze Insert (Male Tube X Tube SW)

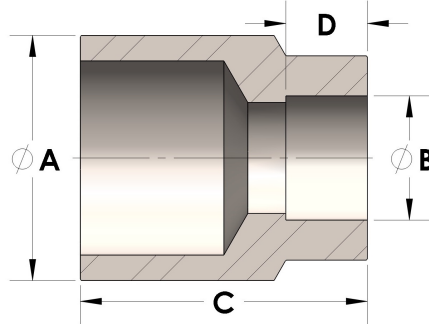

## DIMENSIONS

A	0.380
B	0.25
C	0.69
D	0.190

## GENERAL

Pressure Rating	6000 PSI
Fitting Material	Monel®, ASTM B164, UNS N04405