

Product Category

H867-08-06-M

Part Description

Direct Weld/Braze Insert (Male Tube X Tube SW)

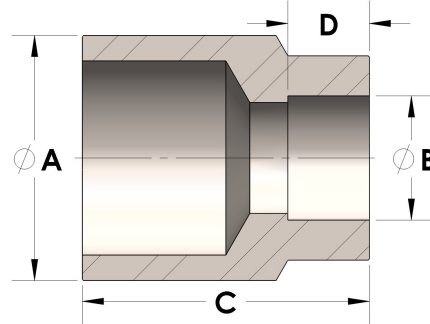

DIMENSIONS

| | |
|---|-------|
| A | 0.500 |
| B | 0.38 |
| C | 0.81 |
| D | 0.250 |

GENERAL

| | |
|------------------|-------------------------------|
| Pressure Rating | 6000 PSI |
| Fitting Material | Monel®, ASTM B164, UNS N04405 |