

Product Category

H867-10-08-S

Part Description

Direct Weld/Braze Insert (Male Tube X Tube SW)

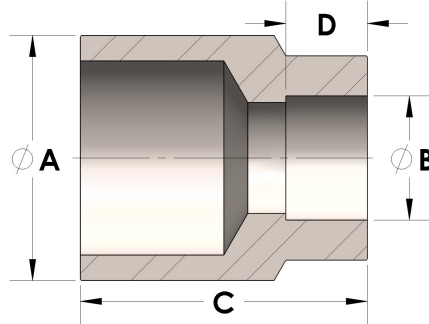

DIMENSIONS

A	0.630
B	0.50
C	0.94
D	0.310

GENERAL

Pressure Rating	4500 PSI
Fitting Material	Carbon Steel, ASTM A108