

Product Category

H867-16-04-M

Part Description

Direct Weld/Braze Insert (Male Tube X Tube SW)

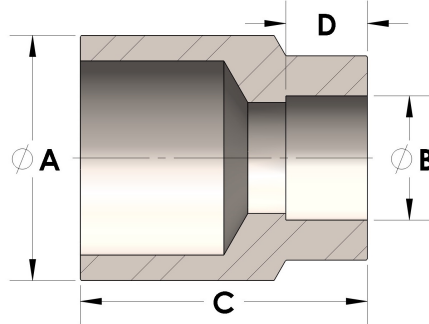

DIMENSIONS

A	1.000
B	0.25
C	1.06
D	0.190

GENERAL

Pressure Rating	4500 PSI
Fitting Material	Monel®, ASTM B164, UNS N04405