

Product Category

H867-20-04-S

Part Description

Direct Weld/Braze Insert (Male Tube X Tube SW)

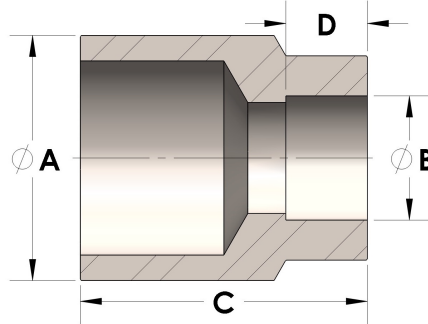

DIMENSIONS

A	1.250
B	0.25
C	1.25
D	0.190

GENERAL

Pressure Rating	4500 PSI
Fitting Material	Carbon Steel, ASTM A108