

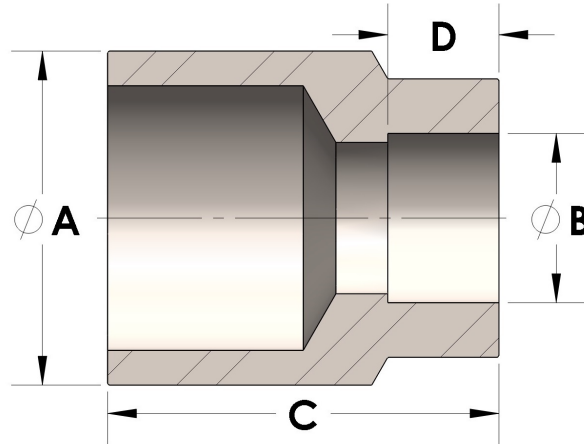

Product Category
Part Description

H867-24-06-S
Direct Weld/Braze Insert (Male Tube X Tube SW)



DIMENSIONS

A	1.500
B	0.38
C	1.38
D	0.250

GENERAL

Pressure Rating	3000 PSI
Fitting Material	Carbon Steel, ASTM A108

The complete catalog contents must be reviewed to ensure that the system designer and user make a safe product selection. When selecting products, the total system design must be considered to ensure safe, trouble-free performance. Function, material compatibility, adequate ratings, proper installation, operation, and maintenance are the responsibilities of the system designer and user. Caution: Do not mix or interchange valve components with those of other manufacturers.