

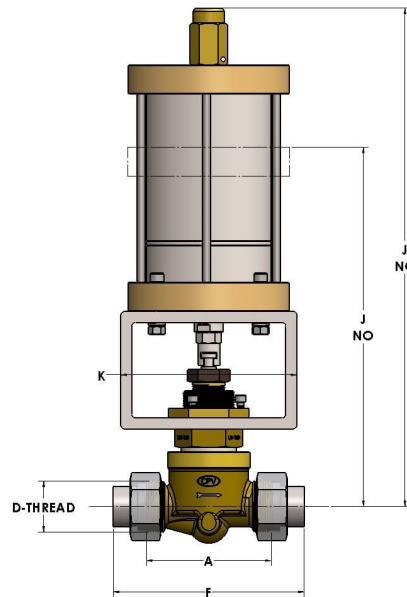

Product Category
Product Line
Part Description

1380-3-P-OXNB-VC-NO
FloMaster® Actuated OXNB Shutoff Valve (1300 Series)
1/2" Globe Shutoff Oxygen Actuated Valve, Normally Open



DIMENSIONS

Port Dia.	0.5
A	4.250
CRN	0C16868.2
D-THREAD	1.750"-12UN
F	6.50
J (Normally Open)	12.25
K	6

GENERAL

Pressure Rating	4500 PSI
Temperature Range	-15°F to 400°F (-26°C to 204°C)
Standard Soft Goods	[-C] Viton® Packing & O-Rings
Cartridge Type	Shutoff

Connection Type	O-SEAL® Union Thread
Connection Size	1/2"
Body Material	Naval Brass, ASTM B21, UNS C46400
Bonnet Material	Naval Brass, ASTM B21, UNS C46400
CRN	0C16868.2

OPTIONS

Port & Vent Options	[-PA] Port Above Seat (1/8" NPT), [-PB] Port Below Seat (1/8" NPT), '[-VA] Vent Above Seat (3/8"-24 SAE), [-VB] Vent Below Seat (3/8"-24 SAE),
--------------------------------	--

cpvmfg.com | 484.731.4010

The complete catalog contents must be reviewed to ensure that the system designer and user make a safe product selection. When selecting products, the total system design must be considered to ensure safe, trouble-free performance. Function, material compatibility, adequate ratings, proper installation, operation, and maintenance are the responsibilities of the system designer and user. Caution: Do not mix or interchange valve components with those of other manufacturers.