

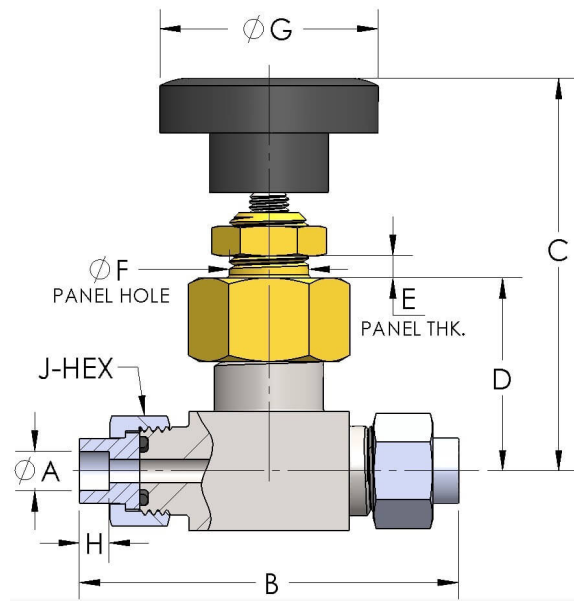

Product Category  
Product Line  
Part Description

8-08SGU-06  
Mark VIII® Shutoff Valve (8-S Series)  
In-line Shutoff Valve with Mark VIII® Ends



## DIMENSIONS

Orifice	0.297
A	0.380
B	3.25
C (Open)	3.47
C (Closed)	3.19
D	1.660
E	0.38
F	0.78
G	1.88
H	0.25
J-HEX	0.94

## GENERAL

<b>Pressure Rating</b>	3000 PSI
<b>Temperature Range</b>	-15°F to 400°F (-26°C to 204°C)
<b>Standard Soft Goods</b>	[-C] Viton® O-Rings
<b>Cartridge Type</b>	Shutoff
<b>Connection Type</b>	Mark VIII® Union Thread
<b>Tube O.D.</b>	3/8"
<b>Body Material</b>	316/L Stainless Steel, ASTM A276, UNS S31603
<b>Bonnet Material</b>	Nickel Aluminum Bronze, ASTM B150, UNS C63200

## OPTIONS

<b>Optional Soft Goods</b>	[-B] Buna-N O-Rings, [-D] EPDM O-Rings
----------------------------	--

[cpvmfg.com](http://cpvmfg.com) | 484.731.4010

The complete catalog contents must be reviewed to ensure that the system designer and user make a safe product selection. When selecting products, the total system design must be considered to ensure safe, trouble-free performance. Function, material compatibility, adequate ratings, proper installation, operation, and maintenance are the responsibilities of the system designer and user. Caution: Do not mix or interchange valve components with those of other manufacturers.