

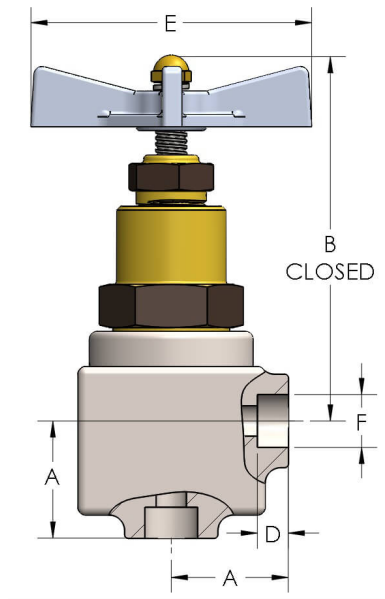

Product Category
Product Line
Part Description

371-0
O-SEAL® Shutoff Valves (300 Series)
1/8" Angle Shutoff Valve with Welded Ends



DIMENSIONS

| | |
|---------------|-------|
| Port Dia. | 0.22 |
| A | 1.380 |
| B | 3.56 |
| D | 0.380 |
| E | 3.50 |
| F (Pipe Size) | 0.420 |
| F (Tube Size) | 0.252 |
| Lift | 0.19 |

GENERAL

| | |
|---------------------|---|
| Pressure Rating | 6000 PSI |
| Temperature Range | -15°F to 275°F (-26°C to 135°C) |
| Standard Soft Goods | [-G] Polyurethane® Packing and Viton® O-Rings |

| | |
|------------------------|---|
| Cartridge Type | Shutoff |
| Connection Type | Socketweld |
| Connection Size | 1/8" |
| Body Material | 316/L Stainless Steel, ASTM A276, UNS S31603 |
| Bonnet Material | Nickel Aluminum Bronze, ASTM B150, UNS C63200 |

OPTIONS

| | |
|--------------------------------|---|
| [-VC] Vacuum Service | Option to add additional softgoods for internal vacuum service. |
| [-P] Panel Mount | Option to add external thread and panel mounting nut to bonnet |
| Port & Vent Options | [-PA] Port Above Seat (1/8" NPT), [-PB] Port Below Seat (1/8" NPT), [-VA] Vent Above Seat (3/8"-24 SAE), [-VB] Vent Below Seat (3/8"-24 SAE), |
| Optional Soft Goods | [-B] Polyurethane® Packing and Buna-N O-Rings, [-C] Viton® Packing & O-Rings, [-D] EPDM Packing & O-Rings |

cpvmfg.com | 484.731.4010

The complete catalog contents must be reviewed to ensure that the system designer and user make a safe product selection. When selecting products, the total system design must be considered to ensure safe, trouble-free performance. Function, material compatibility, adequate ratings, proper installation, operation, and maintenance are the responsibilities of the system designer and user. Caution: Do not mix or interchange valve components with those of other manufacturers.