

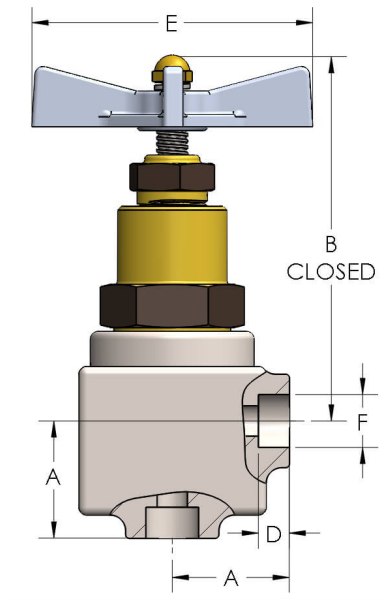

Product Category
Product Line
Part Description

371-2
O-SEAL® Shutoff Valves (300 Series)
3/8" Angle Shutoff Valve with Welded Ends



DIMENSIONS

Port Dia.	0.44
A	1.750
B	4.50
D	0.440
E	3.50
F (Pipe Size)	0.690
F (Tube Size)	0.502
Lift	0.44

GENERAL

Pressure Rating	6000 PSI
Temperature Range	-15°F to 275°F (-26°C to 135°C)
Standard Soft Goods	[-G] Polyurethane® Packing and Viton® O-Rings

Cartridge Type	Shutoff
Connection Type	Socketweld
Connection Size	3/8"
Body Material	316/L Stainless Steel, ASTM A276, UNS S31603
Bonnet Material	Nickel Aluminum Bronze, ASTM B150, UNS C63200

OPTIONS

[-VC] Vacuum Service	Option to add additional softgoods for internal vacuum service.
[-P] Panel Mount	Option to add external thread and panel mounting nut to bonnet
Port & Vent Options	[-PA] Port Above Seat (1/8" NPT), [-PB] Port Below Seat (1/8" NPT), [-VA] Vent Above Seat (3/8"-24 SAE), [-VB] Vent Below Seat (3/8"-24 SAE),
Optional Soft Goods	[-B] Polyurethane® Packing and Buna-N O-Rings, [-C] Viton® Packing & O-Rings, [-D] EPDM Packing & O-Rings

cpvmfg.com | 484.731.4010

The complete catalog contents must be reviewed to ensure that the system designer and user make a safe product selection. When selecting products, the total system design must be considered to ensure safe, trouble-free performance. Function, material compatibility, adequate ratings, proper installation, operation, and maintenance are the responsibilities of the system designer and user. Caution: Do not mix or interchange valve components with those of other manufacturers.