

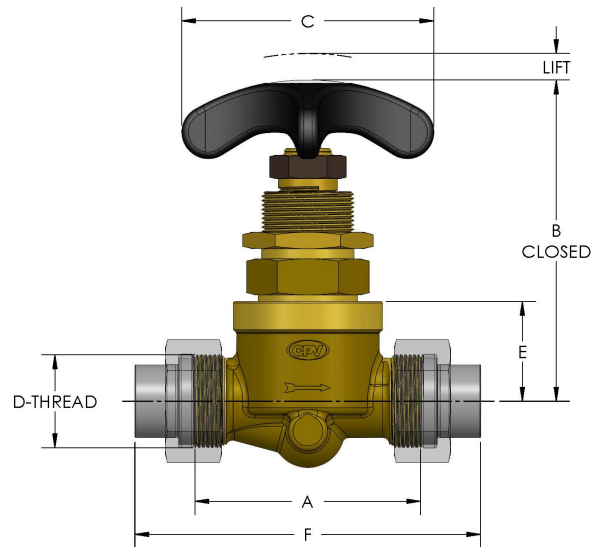

Product Category
Product Line
Part Description

580-4-P-OXNB-VC
OXNB Stop-Check Valve (500 Series)
3/4" Globe Stop-Check Oxygen Hand Valve



DIMENSIONS

Port Dia.	0.63
A	4.630
B	6.25
C	5.25
CRN	0C16868.2
D-THREAD	2.000"-12UN
E	2.81
F	6.88
Lift	0.56

GENERAL

Pressure Rating	4500 PSI
Temperature Range	-15°F to 400°F (-26°C to 204°C)
Standard Soft Goods	[-C] Viton® Packing & O-Rings

Cartridge Type	Stop-Check
Connection Type	O-SEAL® Union Thread
Connection Size	3/4"
Body Material	Naval Brass, ASTM B21, UNS C46400
Bonnet Material	Naval Brass, ASTM B21, UNS C46400
CRN	0C16868.2

OPTIONS

Port & Vent Options	[-PA] Port Above Seat (1/4" NPT), [-PB] Port Below Seat (1/4" NPT), '[-VA] Vent Above Seat (1/2"-13 SAE), [-VB] Vent Below Seat (1/2"-13 SAE),
--------------------------------	--

cpvmfg.com | 484.731.4010

The complete catalog contents must be reviewed to ensure that the system designer and user make a safe product selection. When selecting products, the total system design must be considered to ensure safe, trouble-free performance. Function, material compatibility, adequate ratings, proper installation, operation, and maintenance are the responsibilities of the system designer and user. Caution: Do not mix or interchange valve components with those of other manufacturers.